

BRIVILOR[®]
BONAMAT

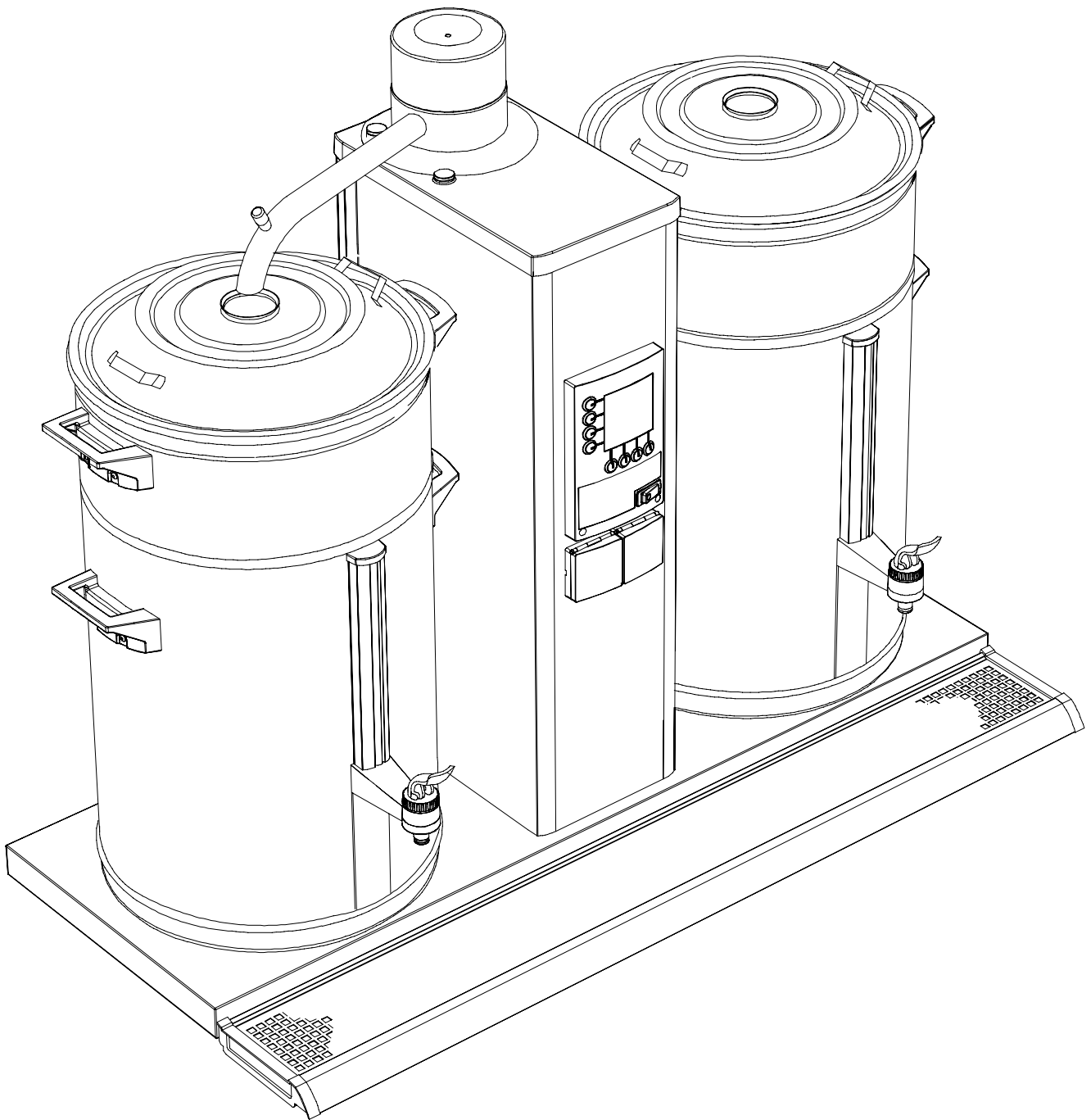



















Gebrauchsanweisungen (kurz)
Bilder

RUND FILTER KAFFEEMASCHINEN



B-series

700.403.800A
(Digital DE)

	<i>English</i>	<i>Deutsch</i>
1.	 Use	Tägliche Benutzung
	 Dripping	Tropfend
2.	 Cleaning, frequently	Reinigung, häufig
	 Wait	Warten
	 Acoustic signal	Akustisches Signal
3.	 Descaling	Entkalken
	 Read Operating Instructions	Gebrauchsanweisung lesen
4.	Initial use	Anfangswerwendung
5.	Programming (operator)	Programmieren (Benutzer)
	 Selection keys	Auswahltasten
	 Confirm	Bestätigen
	 Cancel	Abbrechen
	 Water hardness	Wasserhärte
	 Read Operating Instructions	Gebrauchsanweisung lesen
6.	Programming (principal)	Programmieren (Hauptbenutzer)
	 Selection keys	Auswahltasten
	 Confirm	Bestätigen
	 Cancel	Abbrechen
	 Off	Aus
	 Min.	Minimum
	 Standard	Standard
	 Max.	Maximum
	 Water hardness	Wasserhärte
	 Read Operating Instructions	Gebrauchsanweisung lesen
	Hold 10 sec.	10 Sekunden halten
Select desired time setting (1-14)	Gewünschte Zeiteinstellung wählen (1-14)	
7.	Error codes	Fehlercodes

1. Tägliche Benutzung (B)

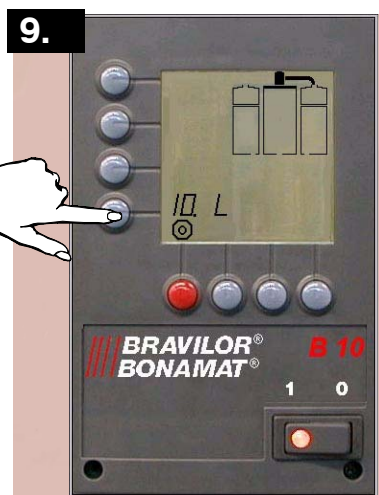
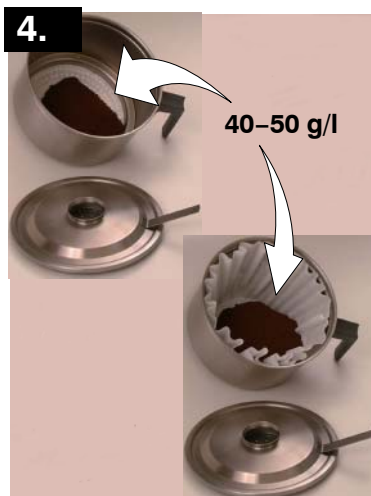
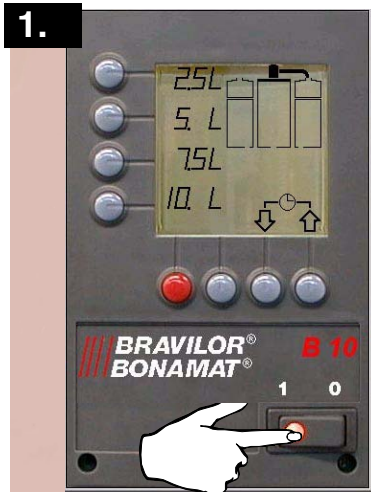

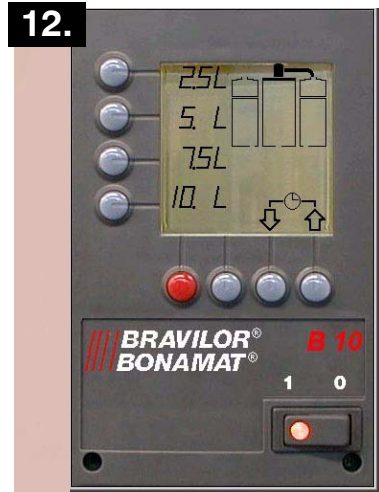

2. REINIGUNG, HÄUFIG (B)

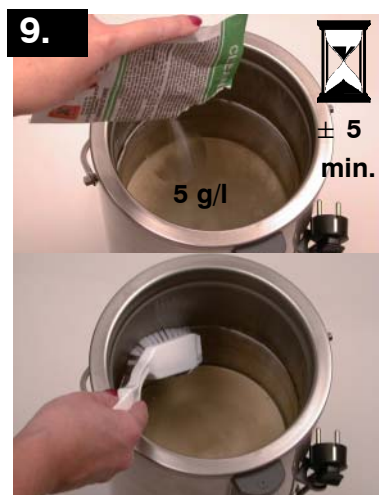
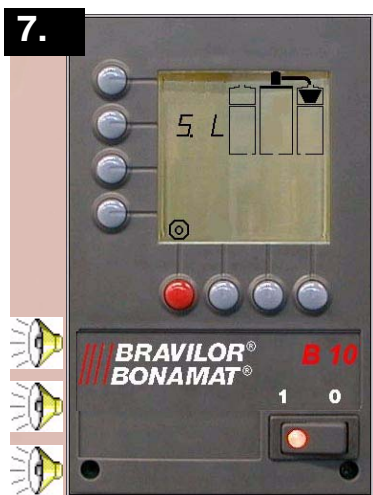
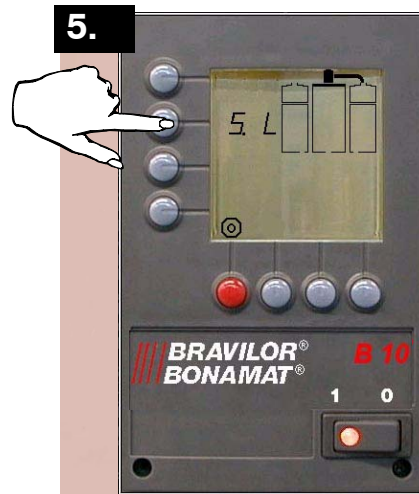
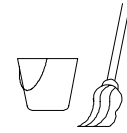

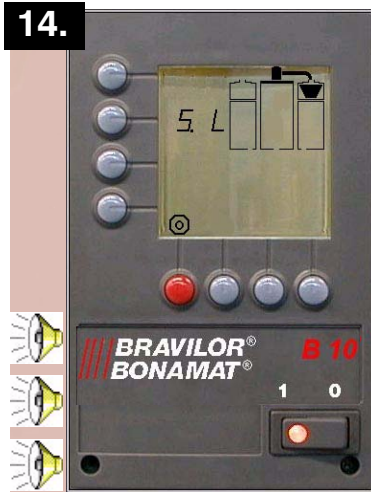
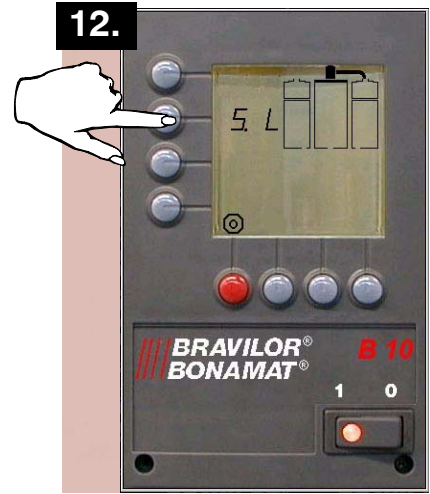



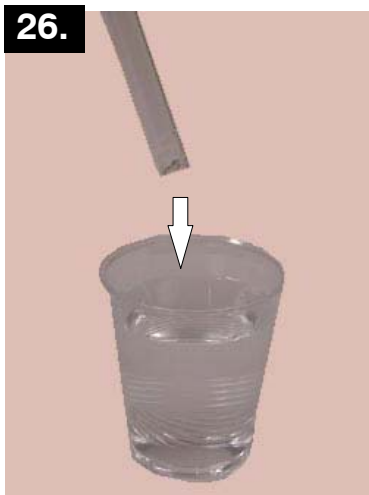

3. ENTKALKEN (B) ± 30 MIN. (BENUTZER)

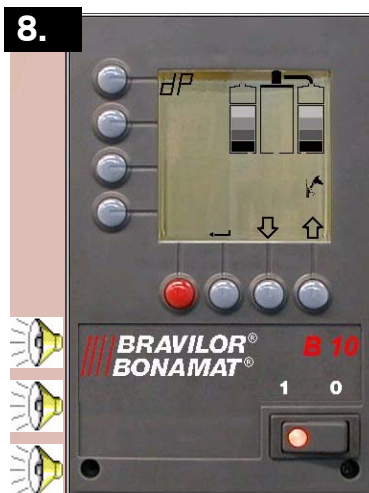
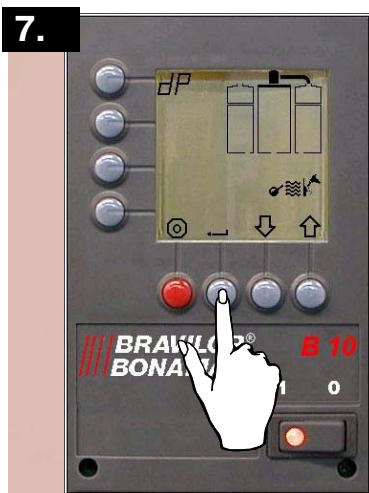
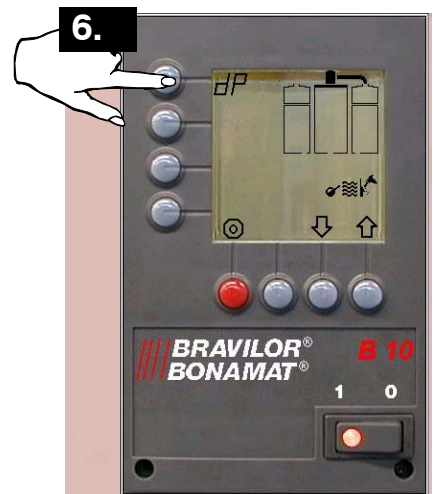
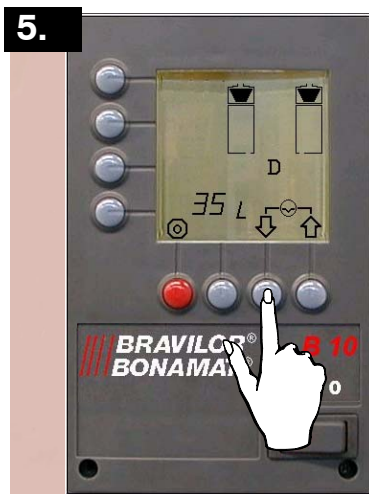
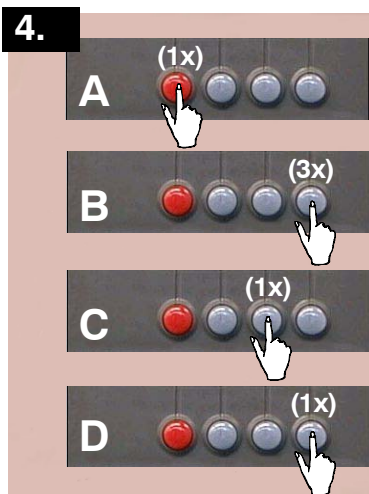
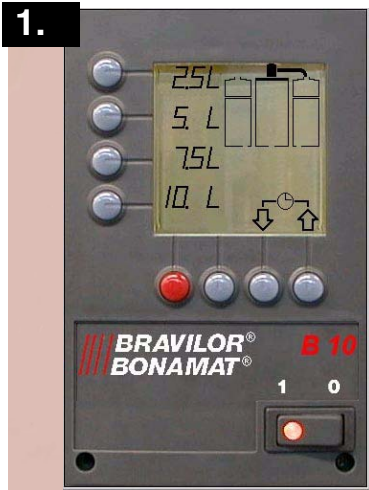

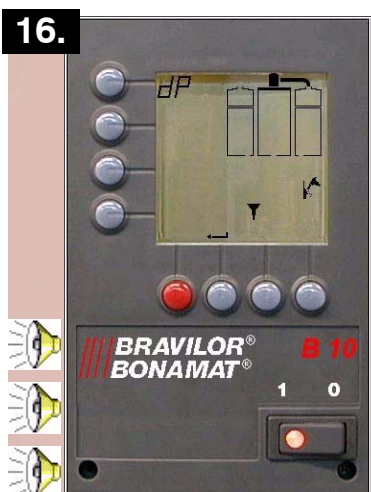
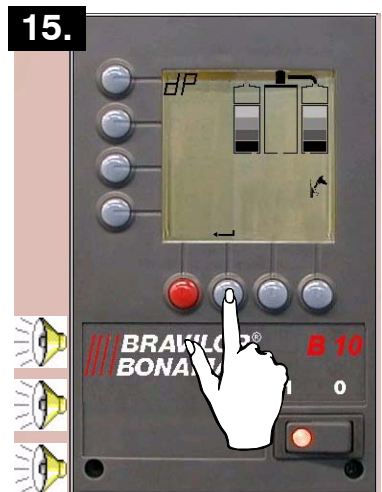
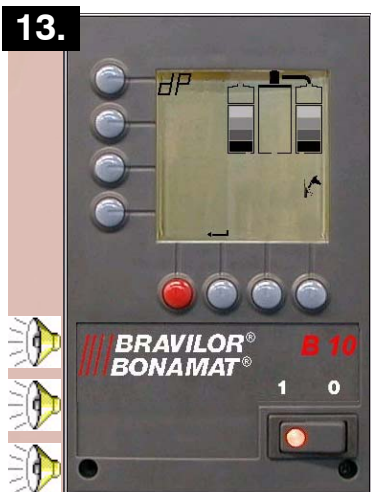
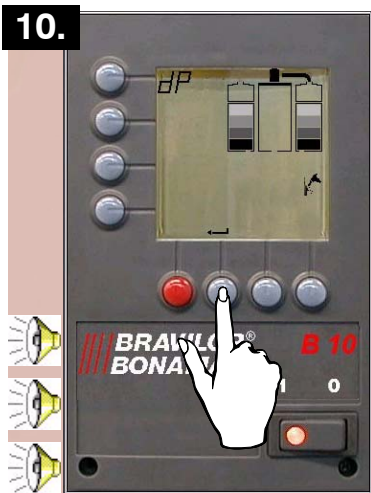

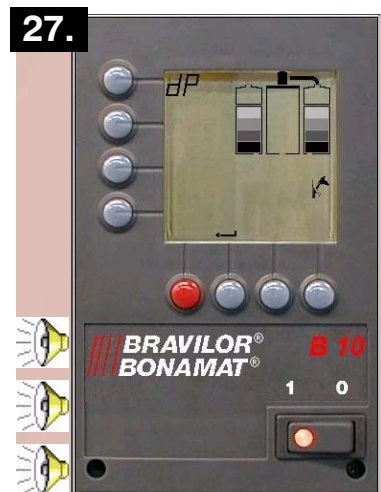
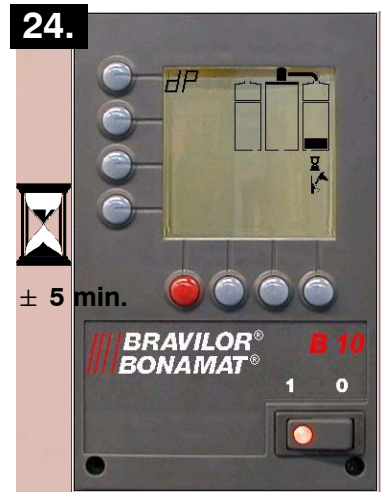
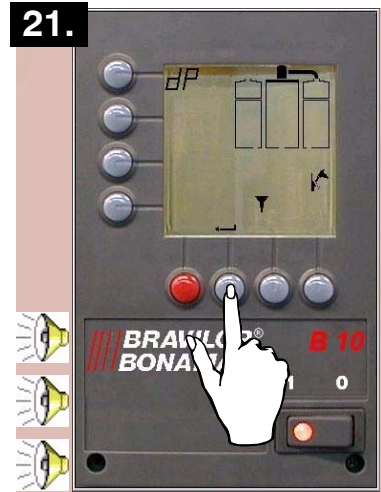

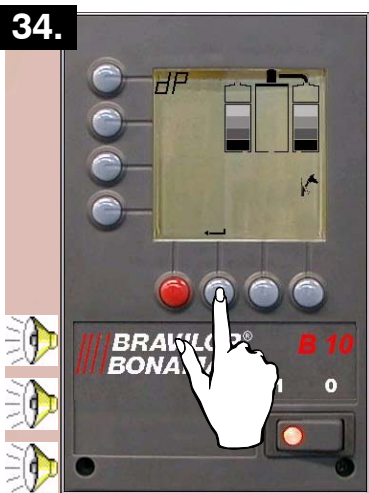
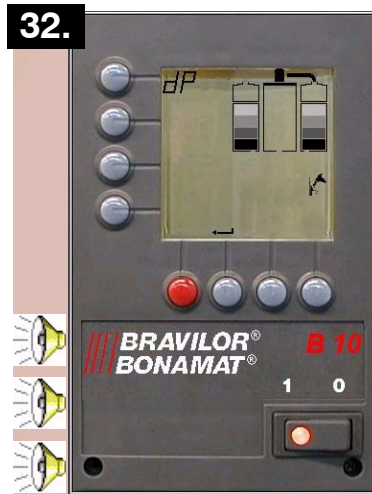
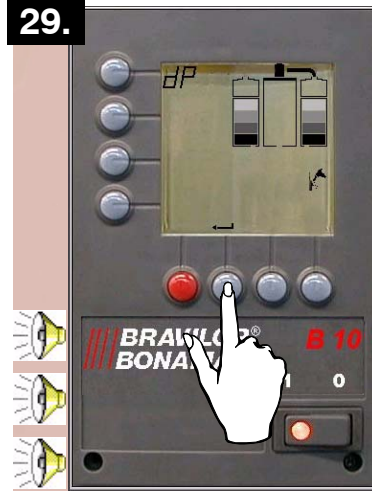

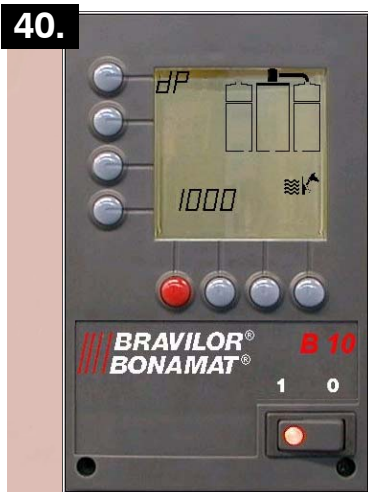
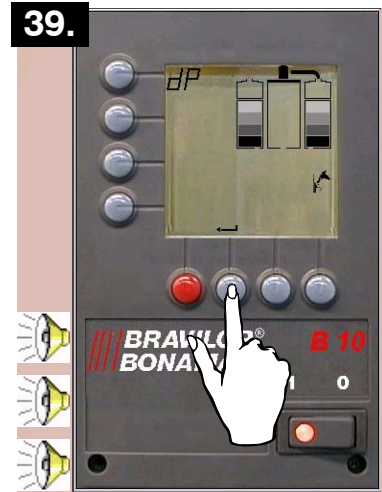
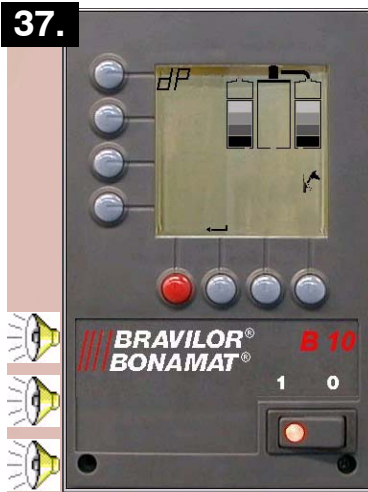



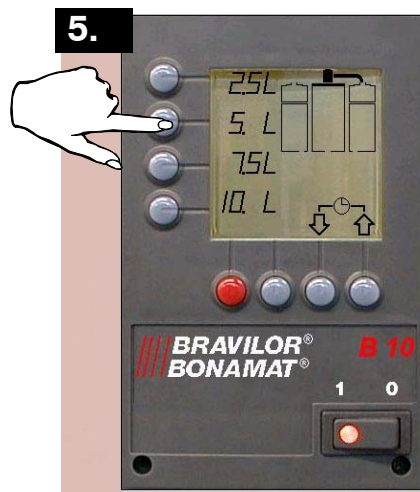
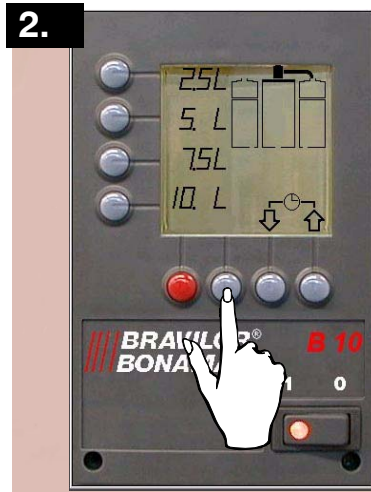
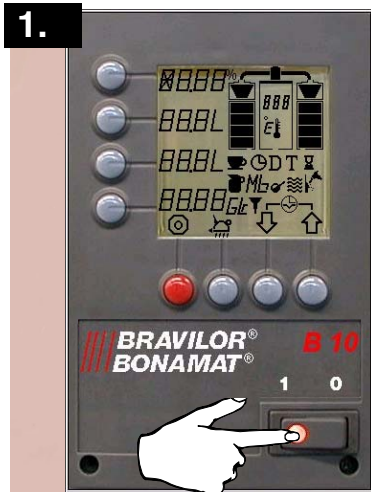

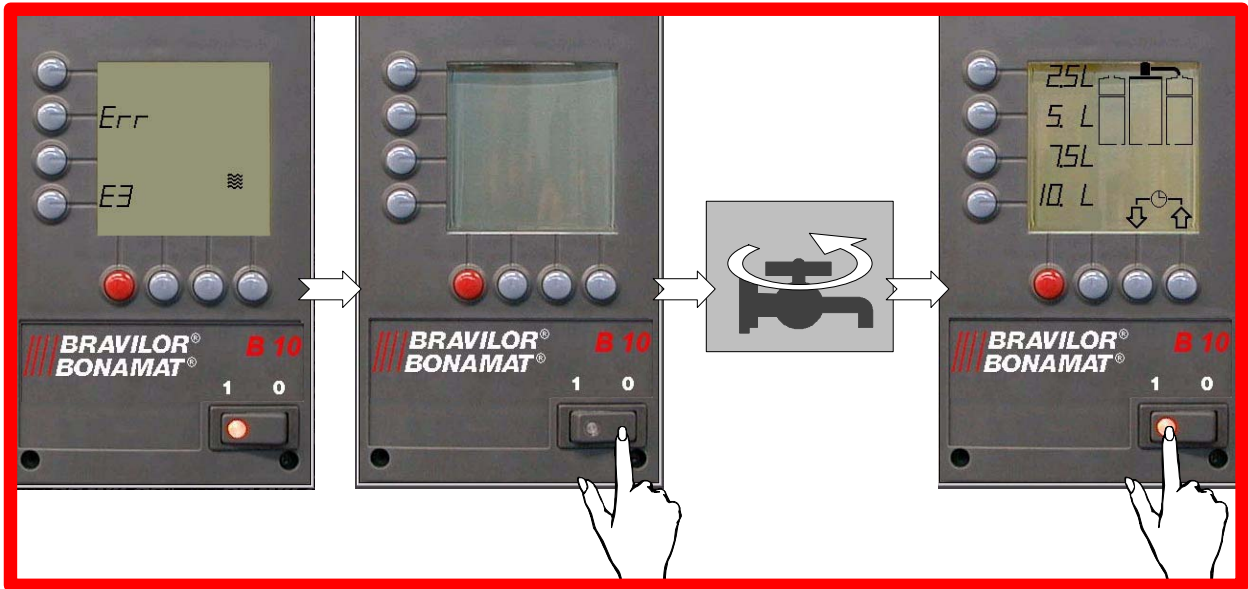



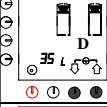

4. ANFANGSVERWENDUNG (B)

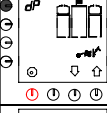

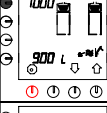

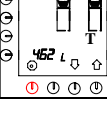

5. PROGRAMMIEREN (B) (BENUTZER)

			= 0	
			§ 3.	
				
				

6. PROGRAMMIEREN (B) (HAUPTBENUTZER)

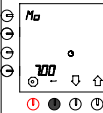
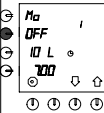
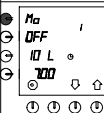
						<table border="1"> <tr><td>B5</td><td>4.8</td><td>5.3</td><td>5.8</td></tr> <tr><td>B10</td><td>10.6</td><td>9.6</td><td>11.6</td></tr> <tr><td>B20</td><td>19.2</td><td>21.2</td><td>23.2</td></tr> <tr><td>B40</td><td>38.4</td><td>42.4</td><td>46.4</td></tr> </table>	B5	4.8	5.3	5.8	B10	10.6	9.6	11.6	B20	19.2	21.2	23.2	B40	38.4	42.4	46.4																																																																																																						
B5	4.8	5.3	5.8																																																																																																																									
B10	10.6	9.6	11.6																																																																																																																									
B20	19.2	21.2	23.2																																																																																																																									
B40	38.4	42.4	46.4																																																																																																																									
						<table border="1"> <tr><td>B5</td><td>1</td><td>1</td><td>3</td><td>4</td><td>5</td><td>5</td></tr> <tr><td>B10</td><td>2</td><td>2.5</td><td>5</td><td>7.5</td><td>10</td><td>10</td></tr> <tr><td>B20</td><td>4</td><td>5</td><td>10</td><td>15</td><td>20</td><td>20</td></tr> <tr><td>B40</td><td>8</td><td>10</td><td>20</td><td>30</td><td>40</td><td>40</td></tr> </table> <table border="1"> <tr><td>50</td><td>125</td><td>200</td></tr> </table> <table border="1"> <tr><td>B5</td><td>8</td><td>8</td><td>24</td><td>32</td><td>40</td><td>40</td></tr> <tr><td>B10</td><td>20</td><td>20</td><td>40</td><td>60</td><td>80</td><td>80</td></tr> <tr><td>B20</td><td>40</td><td>40</td><td>80</td><td>120</td><td>160</td><td>160</td></tr> <tr><td>B40</td><td>80</td><td>80</td><td>160</td><td>240</td><td>320</td><td>320</td></tr> </table> <table border="1"> <tr><td>50</td><td>250</td><td>3000</td></tr> </table> <table border="1"> <tr><td>B5</td><td>4</td><td>4</td><td>12</td><td>16</td><td>20</td><td>20</td></tr> <tr><td>B10</td><td>10</td><td>10</td><td>20</td><td>30</td><td>40</td><td>40</td></tr> <tr><td>B20</td><td>20</td><td>20</td><td>40</td><td>60</td><td>80</td><td>80</td></tr> <tr><td>B40</td><td>40</td><td>40</td><td>80</td><td>120</td><td>160</td><td>160</td></tr> </table> <table border="1"> <tr><td>B5</td><td>0.30</td><td>0.30</td><td>0.65</td><td>0.95</td><td>1.30</td><td>1.30</td></tr> <tr><td>B10</td><td>0.65</td><td>0.65</td><td>1.30</td><td>1.95</td><td>2.60</td><td>2.60</td></tr> <tr><td>B20</td><td>1.30</td><td>1.30</td><td>2.60</td><td>3.95</td><td>5.25</td><td>5.25</td></tr> <tr><td>B40</td><td>2.60</td><td>2.60</td><td>5.25</td><td>7.90</td><td>10.55</td><td>10.55</td></tr> </table>	B5	1	1	3	4	5	5	B10	2	2.5	5	7.5	10	10	B20	4	5	10	15	20	20	B40	8	10	20	30	40	40	50	125	200	B5	8	8	24	32	40	40	B10	20	20	40	60	80	80	B20	40	40	80	120	160	160	B40	80	80	160	240	320	320	50	250	3000	B5	4	4	12	16	20	20	B10	10	10	20	30	40	40	B20	20	20	40	60	80	80	B40	40	40	80	120	160	160	B5	0.30	0.30	0.65	0.95	1.30	1.30	B10	0.65	0.65	1.30	1.95	2.60	2.60	B20	1.30	1.30	2.60	3.95	5.25	5.25	B40	2.60	2.60	5.25	7.90	10.55	10.55
B5	1	1	3	4	5	5																																																																																																																						
B10	2	2.5	5	7.5	10	10																																																																																																																						
B20	4	5	10	15	20	20																																																																																																																						
B40	8	10	20	30	40	40																																																																																																																						
50	125	200																																																																																																																										
B5	8	8	24	32	40	40																																																																																																																						
B10	20	20	40	60	80	80																																																																																																																						
B20	40	40	80	120	160	160																																																																																																																						
B40	80	80	160	240	320	320																																																																																																																						
50	250	3000																																																																																																																										
B5	4	4	12	16	20	20																																																																																																																						
B10	10	10	20	30	40	40																																																																																																																						
B20	20	20	40	60	80	80																																																																																																																						
B40	40	40	80	120	160	160																																																																																																																						
B5	0.30	0.30	0.65	0.95	1.30	1.30																																																																																																																						
B10	0.65	0.65	1.30	1.95	2.60	2.60																																																																																																																						
B20	1.30	1.30	2.60	3.95	5.25	5.25																																																																																																																						
B40	2.60	2.60	5.25	7.90	10.55	10.55																																																																																																																						
						<table border="1"> <tr><td>88</td><td>97</td><td>97</td></tr> </table> <table border="1"> <tr><td>190</td><td>206</td><td>206</td></tr> </table>	88	97	97	190	206	206																																																																																																																
88	97	97																																																																																																																										
190	206	206																																																																																																																										
						<p>▲ EnG</p> <p>□ ■ dEu, FrA, ESP, nEd</p> <p>▲</p> <p>☒ - - - - - ■</p> <p>off on</p>																																																																																																																						

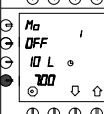
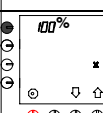
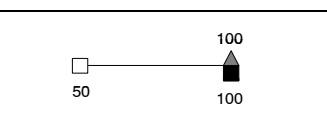
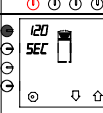
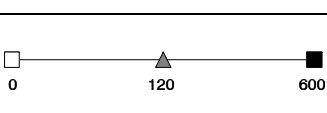
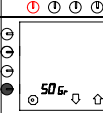
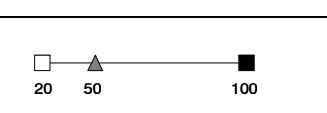
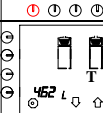
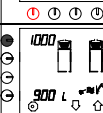
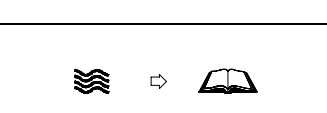
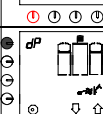
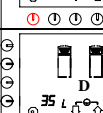
		<p>↓ / ↑</p> <p>Gewünschte Zeiteinstellung wählen (1-14).</p>			<p>← / ⊙</p>	<p>▲</p> <p>☒ - - - - ■</p> <p>off on</p>	
	<p>↓ ↑</p>				<p>↓ / ↑</p>		
					<p>← / ⊙</p>		
				<p>↓ / ↑</p>	<p>← / ⊙</p>		
	<p>↓ ↑</p>		<p>↓</p>	<p>←</p>	<p>↓ / ↑</p>	<p>← / ⊙</p>	
	<p>↓ ↑</p>				<p>↓ / ↑</p>	<p>← / ⊙</p>	
	<p>↓ ↑</p>				<p>↓ / ↑</p>	<p>← / ⊙</p>	
	<p>↓ ↑</p>				<p>↓ / ↑</p>		
	<p>↓ ↑</p>				<p>↓ / ↑</p>	<p>← / ⊙</p>	
	<p>↓ ↑</p>						§ 3. (Benutzer)
	<p>↓ ↑</p>				<p>↓ + ↑</p>		= 0

7. FEHLERCODES (B)

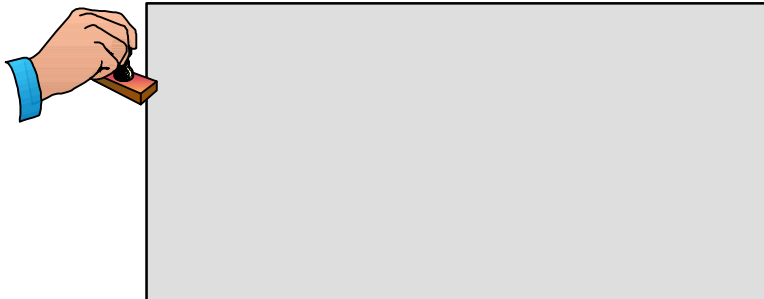
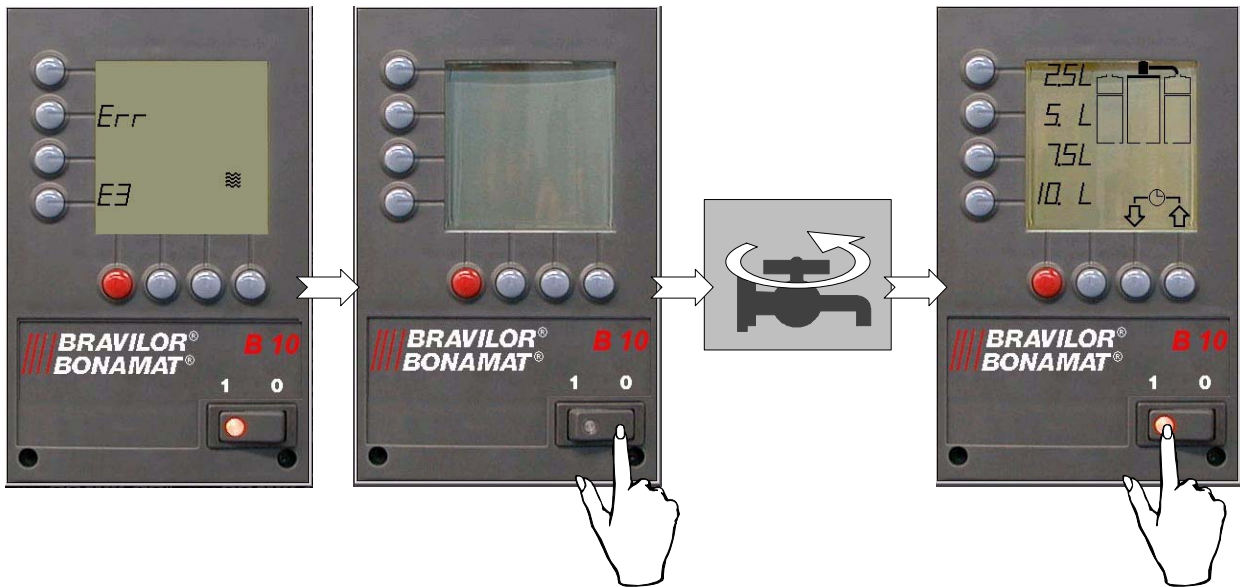



700.403.800A (Digital DE)

/// BRAVILOR[®]
BONAMAT

COFFEE BREWING MACHINES
MACHINES A CAFE
KAFFEEBRUEHMASCHINEN
KOFFIEZETAPPARATEN

© 11-2001